

PRIMERGY BX900 S2 System Unit

System configurator and order-information guide

Contents

Instructions

Configuration diagram

Configurator

- I **BX900 System Units**
- II **BX900 Server Blades**
- III **BX900 Storage Blades**
- IV **Connection Blade Overview**
- V **Connection Blades Ethernet**
- VI **Connection Blades Fibre Channel**
- VII **Connection Blade InfiniBand**
- VIII **Connection Blade SAS**



Change report

PRIMERGY Server

Instructions

This document contains basic product and configuration information that will enable you to configure your system via System-Architect.

Only the tool "System-Arcitect" will ensure a fast and proper configuration of your PRIMERGY server or your complete PRIMERGY Rack system.

Please pay attention to the naming conventions: **BX900 S2** System unit 1st generation

You can configure your individual PRIMERGY server in order to adjust your specific requirements.

The System configurator is divided into several chapters that are identical to the current price list and PC-/ System-Architect.

Please follow the lines. If there is a junction, you can choose which way or component you would like to take. Go through the configurator by following the lines from the top to the bottom.

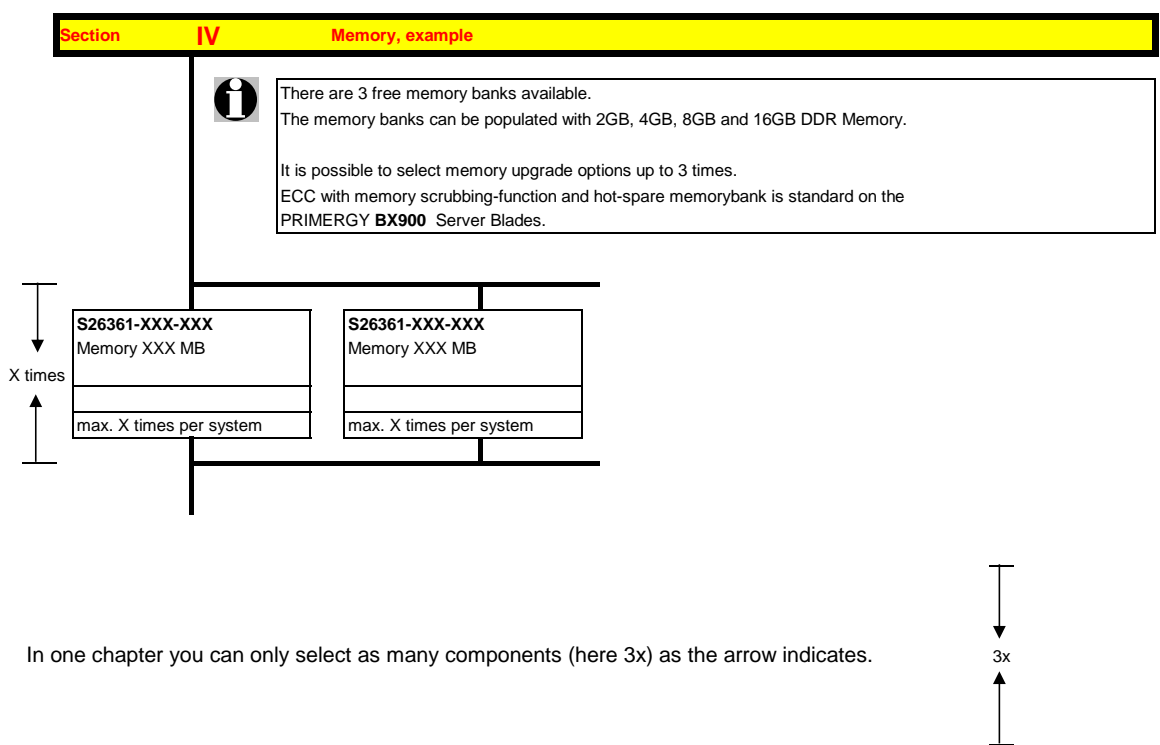

In one chapter you can only select as many components (here 3x) as the arrow indicates.

Please note that there are information symbols which indicate necessary information.



For further information see:

http://ts.fujitsu.com/products/standard_servers/index.html (internet)

https://partners.ts.fujitsu.com/com/order-supply/configurators/primergy_config/Pages/Currentconfigur (extranet)

Prices and availability see price list and PC-/ System-Architect
 Subject to change and errors excepted

Configuration diagram BX900 S2 System Unit

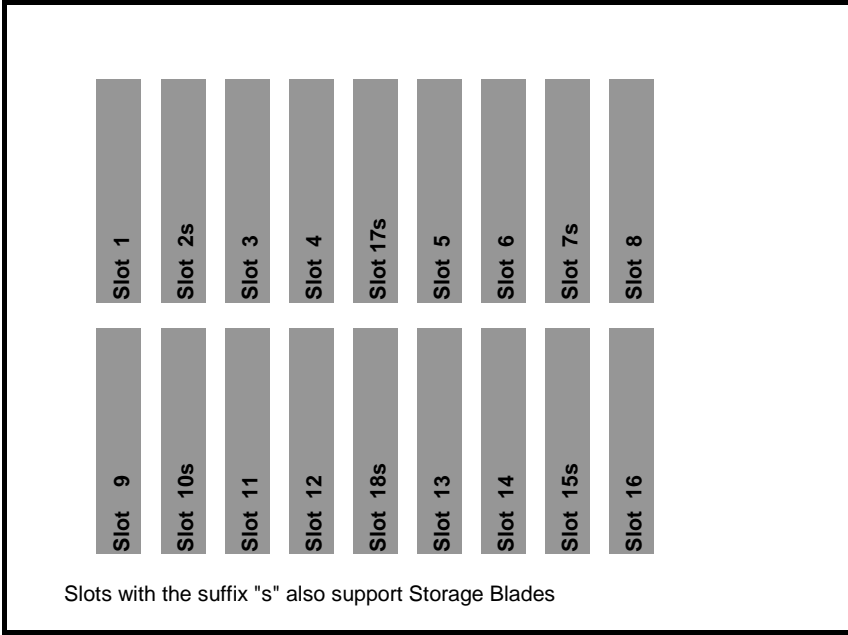

Extension slots front side

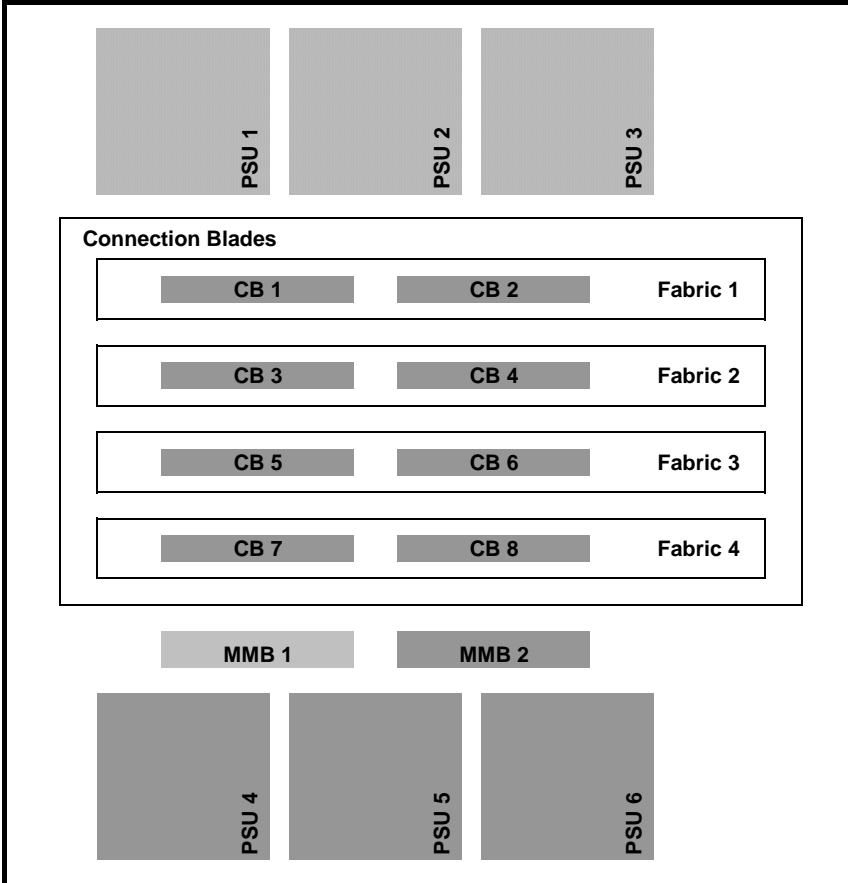

Extension slots rear side



Key:

-  Included in basic unit
-  Option

PSU slots may also be equipped with Rear Fan Modules
 (see next page for details on power and cooling)

Section System Unit BX900 S2

S26361-K1421-V300
 The System Unit BX900 S2 without PSU consists of:

- * 10U chassis including
- * Rack mounting kit suitable for
 - PRIMERGY 19" PRIMECENTER Rack, FJ new rack and 3rd party racks (e.g. Rittal)
 - 1 pair of carrier rails and 1 bracket for DC-Rack
- * Drives / bays / slots
 - 18 empty slots for 18 hot-plug Blades at front side.
 - 8 empty slots for Connection Blades at rear side
 - 3 empty slots for additional hot-plug power supplies at rear side
- * 1 hot-plug Management Blade
- * ServerView Local service Panel for Blades

External Interfaces:

- 1x RS-232-C (serial, 9 pin) per Management Blade
- 2x 1Gb Ethernet per Management Blade
- 2x USB per Management Blade
- 1x VGA, 1x serial and 4x USB at front side of each Server Blade via special cable

Cables (shipped with each System Unit):

- 1x special cable with 2x USB for external CD/FD and 1x VGA for Server Blade front side connection.

Software:

- ServerView Suite Software package incl. ServerStart, ServerBooks, Management Software and Updates

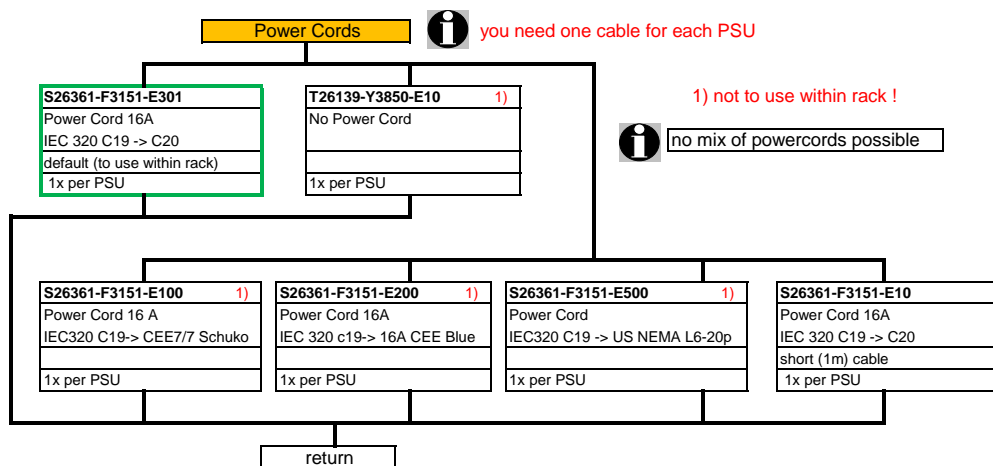
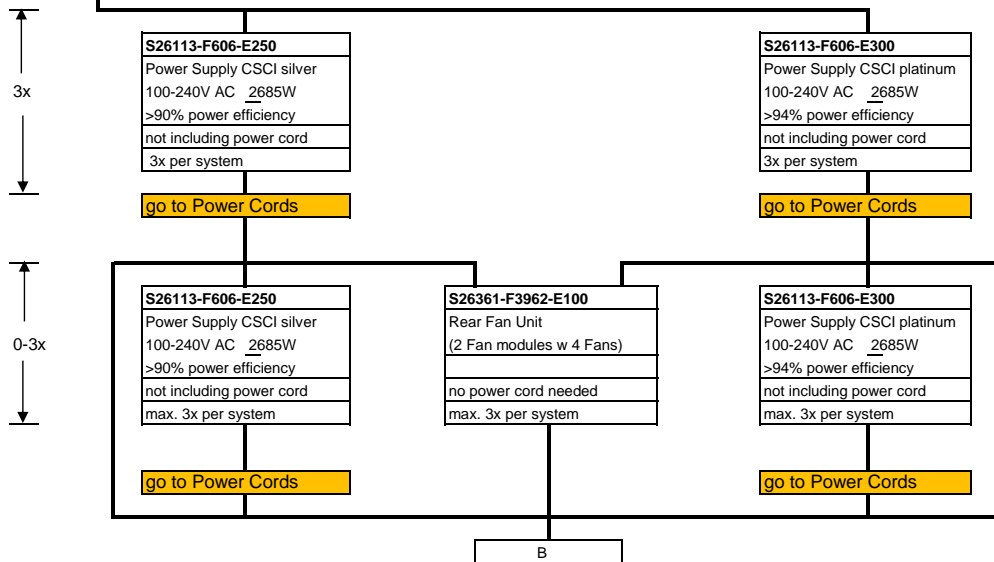

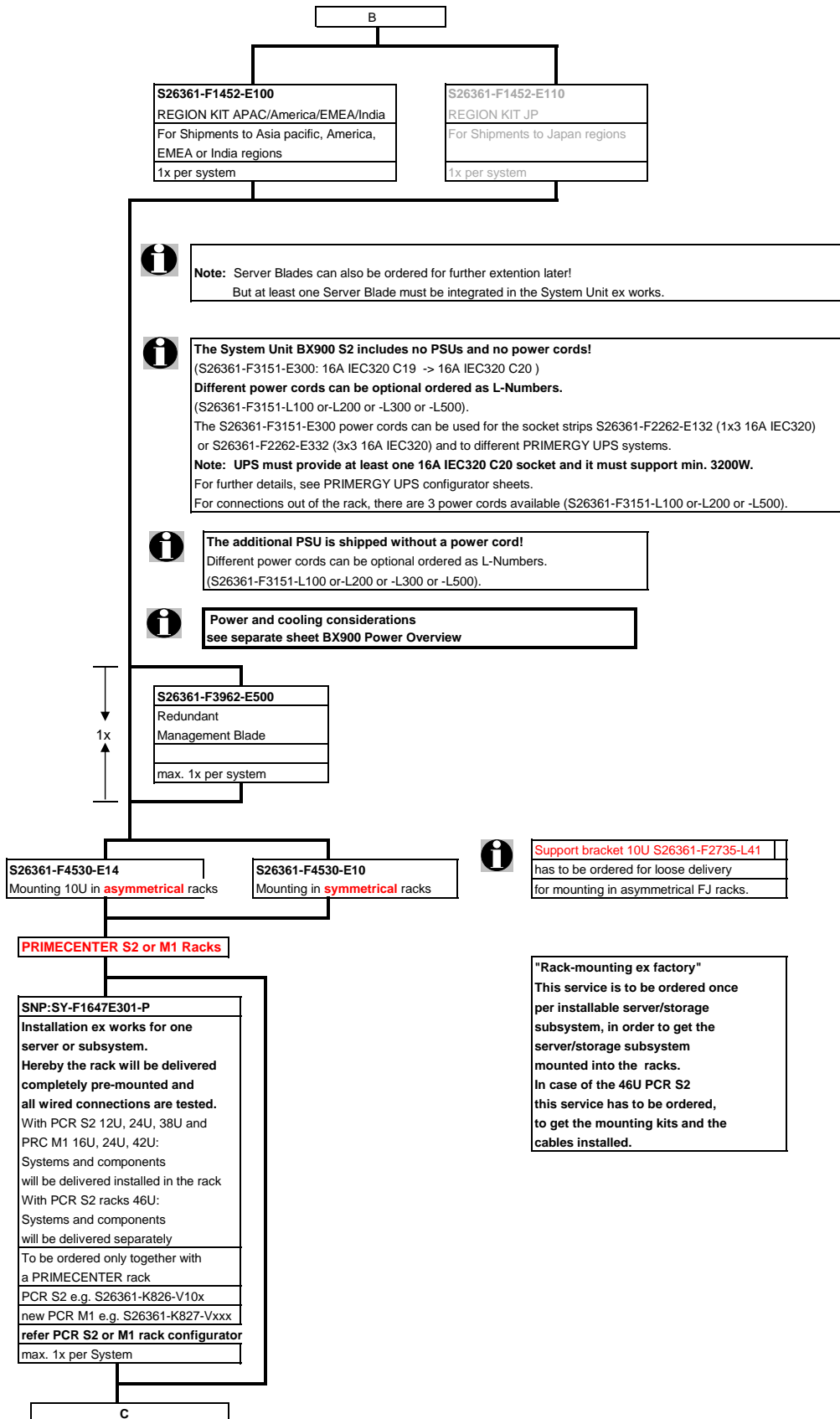

i **Note:** Server Blades can also be ordered for further extension later!
 But at least one Server Blade must be integrated in the System Unit ex works.

i **The System Unit BX900 S2 includes no PSUs and no power cords!**
 (S26361-F3151-E300: 16A IEC320 C19 -> 16A IEC320 C20)
Different power cords can be optional ordered as L-Numbers.
 (S26361-F3151-L100 or-L200 or -L300 or -L500).
 The S26361-F3151-E300 power cords can be used for the socket strips S26361-F2262-E132 (1x3 16A IEC320)
 or S26361-F2262-E332 (3x3 16A IEC320) and to different PRIMERGY UPS systems.
Note: UPS must provide at least one 16A IEC320 C20 socket and it must support min. 3200W.
 For further details, see PRIMERGY UPS configurator sheets.
 For connections out of the rack, there are 3 power cords available (S26361-F3151-L100 or-L200 or -L500).

i **The additional PSU is shipped without a power cord!**
 Different power cords can be optional ordered as L-Numbers.
 (S26361-F3151-L100 or-L200 or -L300 or -L500).

i **Power and cooling considerations**
 see separate sheet BX900 Power Overview

1x
 S26361-F3962-E500
 Redundant Management Blade
 max. 1x per system

S26361-F4530-E14
 Mounting 10U in **asymmetrical** racks

S26361-F4530-E10
 Mounting in **symmetrical** racks

i **Support bracket 10U S26361-F2735-L41**
 has to be ordered for loose delivery
 for mounting in asymmetrical FJ racks.

PRIMECENTER S2 or M1 Racks

SNP:SY-F1647E301-P
Installation ex works for one server or subsystem.
Hereby the rack will be delivered completely pre-mounted and all wired connections are tested.
 With PCR S2 12U, 24U, 38U and PRC M1 16U, 24U, 42U:
 Systems and components will be delivered installed in the rack
 With PCR S2 racks 46U:
 Systems and components will be delivered separately
 To be ordered only together with a PRIMECENTER rack
 PCR S2 e.g. S26361-K826-V10x
 new PCR M1 e.g. S26361-K827-Vxxx
refer PCR S2 or M1 rack configurator
 max. 1x per System

"Rack-mounting ex factory"
This service is to be ordered once per installable server/storage subsystem, in order to get the server/storage subsystem mounted into the racks.
In case of the 46U PCR S2 this service has to be ordered, to get the mounting kits and the cables installed.

C

For more configuration information see the separate Server Blade configurator at:
https://partners.ts.fujitsu.com/com/order-supply/configurators/primergy_config/current/Pages/default.aspx

Section III Storage Blades in System Unit BX900 S2

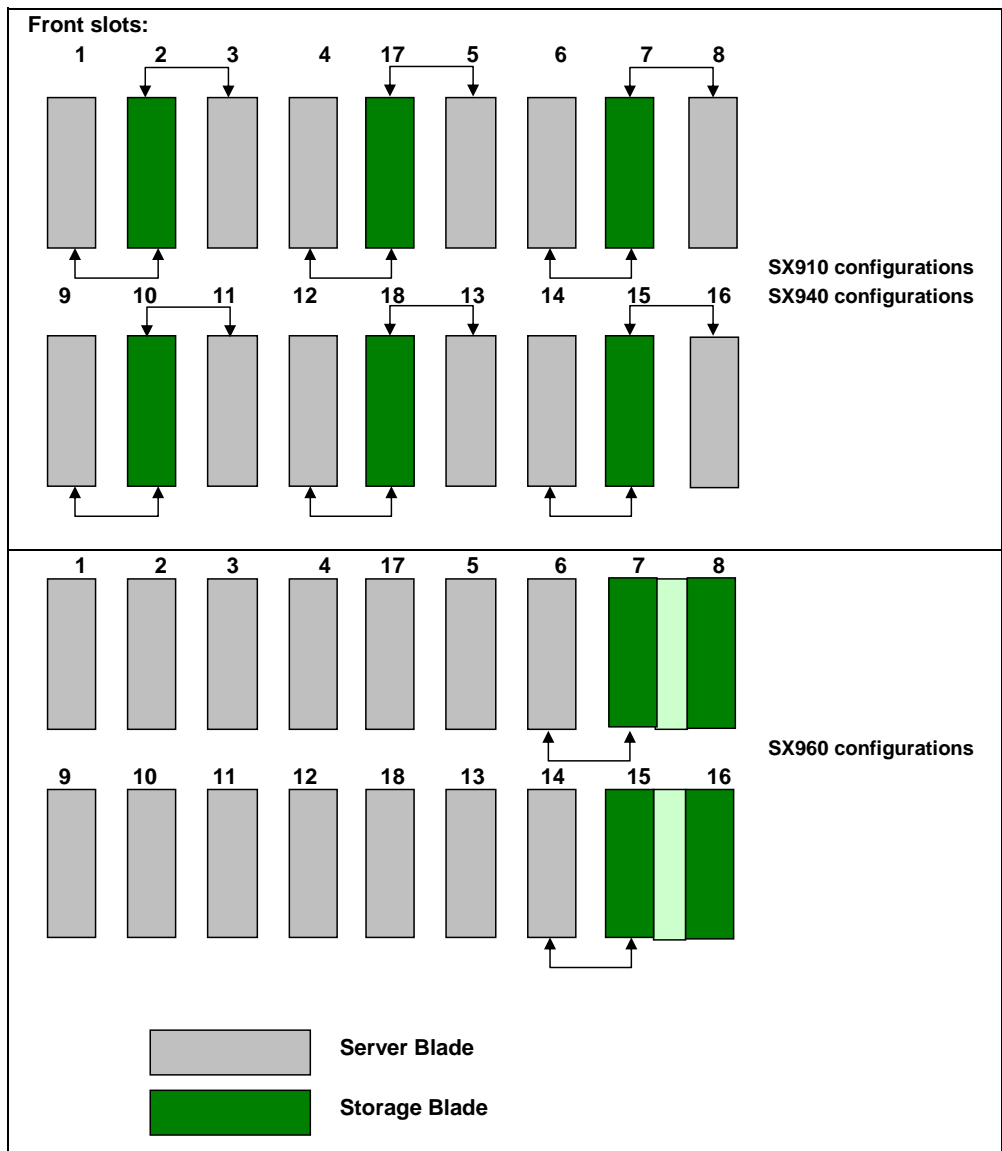

i All described Storage Blades can be inserted into the designated slots of the System Unit.
 For more configuration information see the separate Server Blade configurator at:
https://partners.ts.fujitsu.com/com/order-supply/configurators/primergy_config/current/Pages/default.aspx

max. 6x	S26361-K1292-V200	S26361-K1290-V200	S26361-K1383-V210	S26361-K1383-V220
	PY SX940 S1	PY SX910 S1	PY SX980 S1 JBOD Blade	PY SX980 S2 JBOD Blade
	Storage Blade Disk	Storage Blade Tape	up to 10x SAS HDD	up to 10x SAS HDD
	1x or 2x PCIe Controller up to 4x SAS/SATA HDD max. 6x per system unit	1x PCIe Controller 1x SAS LTO Drive max. 6x per system unit	max. 6x per system unit	redundant SAS paths max. 6x per system unit

i Due to EMI restrictions, for the US market only
 3x SX980 S1 or S2 can be installed in BX900

max. 2x	S26361-K1382-V202
	PY SX960 S1 Storage Blade Disk
	1x SAS RAID Controller up to 10x SAS/SATA HDD max. 2x per system unit

Q

Section II BX900 Power Overview

Configuration Overview

A BX900 chassis has 6 slots for power supplies (PSUs) or Fan Units (RFNs). Limiting factors for mounting blades are available power from PSUs but also cooling which is assured by PSUs or RFNs. As a result there are mounting rules to be followed for servers if less than 6 units (PSUs or RFNs) are used in a BX900 chassis. Also available PSU power has to be considered.

Power table BX900

PSU 2685 W / 100 V AC				PSU 2685 W / 230 V AC	
Number of installed		Max. number		Max. number	
PSU	Fan	Max. Dual Server Blades	PSU redundancy	Max. Dual Server Blades	PSU redundancy
3	0	7	3+0	7	3+0
	1			10	
	2			14	
	3			18	
4	0	10	4+0	10	3+1
	1			14	
	2			18	
5	0	16	5+0	14	3+2
	1			18	
6	0	18	5+1	18	3+3
	0		6+0	18	

E.g. 3+1 means there are 3 base PSUs and 1 redundant unit given.
 2nd column shows the number of additional Rear Fan Units (RFNs). They are needed to provide cooling to additional server blade slots.
 Finally there are further columns showing the different server blades. Here is shown their maximum count which can be operated with the PSU / RFN configuration given on the left.
 Not all configurations may make sense, recommended ones are highlighted green.

Shown here is a configuration with one kind of server blade, only, no mixed configuration.!

Example: A BX900 with 3 standard PSUs at 230VAC and one RFN can support a maximum of 10 BX920 servers.

Connection Blades:

Above tables are calculated with the assumption that 6 Connection Blades (50W each) are mounted

Remark:

Basically mixed configurations of blades are possible. Because of the manifold of possible combinations extra calculations are required to show configuration limits.

C

Section Server Blades in System Unit BX900 S2



All described Server Blades can be mixed in on System Unit with the explained exceptions.
For more configuration information see the separate Server Blade configurator at:
https://partners.ts.fujitsu.com/com/order-supply/configurators/primergy_config/current/Pages/default.aspx

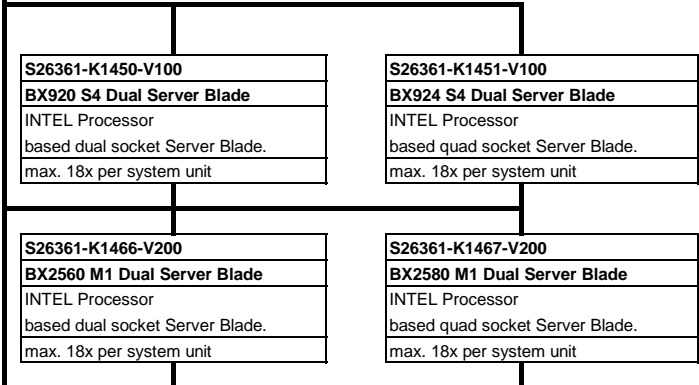

D

R

Section IV Connection Blade Overview



Each PRIMERGY BX900 Server Blade comes with onboard Ethernet LAN channels and special connectors for the optional mezzanine cards.
 below the relationship between Connection Blade Slots and Onboard LAN / Mezzanine slots

Connection Blade	BX92x	Fabric 1		Fabric 2		Fabric 3		Fabric 4	
		Onboard LAN		Mezz Slot 1		Mezz Slot 2		Mezz Slot 2	
K1304-V100	1Gb Eth	X	X	X	X	X	X	X	X
K1304-V101	1Gb Eth	X	X	X	X	X	X	X	X
K1366-V100	1Gb Eth	X	X	X	X	X	X	X	X
K1304-V200	10Gb Eth	X	X	X	X	X	X		
K1533-V100	10/40Gb Eth	X	X	X	X	X	X		
K1365-V18	1/10Gb Eth	X	X	X	X	X ¹⁾	X ¹⁾	X ¹⁾	X ¹⁾
K1440-Vxxx	10Gb Eth	X	X	X	X				
K1305-Vxxx	8Gb FC			X	X	X	X		
K1363-Vxxx	8Gb FC			X	X	X	X		
K1527-Vxxx	16Gb FC			X	X	X	X		
K1326-V200	IB 40Gb				X		X		X
K1423-V200	IB 56Gb				X		X		X
K1391-V300	SAS 6Gb					X	X		

¹⁾ fabric 3 and fabric 4 must not be equipped with an Ethernet Pass Thru (K1365-V18) at the same time

R1

Mezzanine Cards released for BX9xx Server Blades

System	BX920 S2	BX920 S3	BX920 S4	BX922 S2	BX924 S2	BX924 S3	BX924 S4	BX2560M1	BX2580 M1	BX960 S1
ombboard LAN ports	4x 1GbE	2x 10GbE	4x 1GbE	4x 1GbE	2x 10GbE	2x 10GbE	2x 10GbE	2x 10GbE	2x 10GbE	4x 10GbE
mezzanie slots	2 slots	2 slots	2 slots	2 slots	2 slots	2 slots	2 slots	2 slots	2 slots	4 slots
Eth 1Gb 4 Port	S26361-F3331-E1	X	X	X	X	X	X	X	X	X
FC 8Gb 2 Port	S26361-F3874-E1	X	X	X	X	X	X	X	X	X
FC 16Gb 2 Port	S26361-F4994-E402			X			X	X	X	X
IB 40Gb 2 Port	S26361-F3992-E2	X	X	X	X	X	X	X	X	
IB 56Gb 2 Port	S26361-F4534-E1		X				X	X	X	
Eth 10Gb 2 Port	S26361-F3997-E1	X	X	X	X	X	X	X	X	X
SAS HBA Mezz	S26361-F4480-E1	X	X	X	X	X	X	X	X	
SAS RAID Mezz	S26361-F4481-E1	X	X	X	X	X	X	X	X	
CNA 10GB BE3	S26361-F3592-E532		X				X	X	X	

red marked server nodes has sales status 65 -> no longer available

Supportmatrix for Ethernet Connection Blades

Order number	Connection Blade Type	Codename	LAN on Motherboard										Eth 4x 1Gb	Eth 2x 10Gb	Eth 2x 10Gb	Eth 2x 10Gb	FC 2x 8Gb	FC 2x 16Gb		
			BX920 S1/S2 Zoar	BX920 S3/S4 BE3	BX2560 M1/M2 Skyhawk	BX922 S2 Kawela	BX924 S2 Niantic	BX924 S3/S4 BE3	BX2580 M1/M2 Skyhawk	BX960 S1 Niantic	F3331-E1 Zoar	F3997-E1 Niantic							F3592-E502 BE2	F3592-E532 BE3
S26361-K1304-V100	PY CB Eth Sw tch/IBP 1Gb 36/12	SB11A	X	X	X	X	X	X	X	X	X	X	X	X						
S26361-K1304-V101	PY CB Eth Sw tch/IBP 1Gb 36/8+2	SB11	X	X	X	X	X	X	X	X	X	X	X							
S26361-K1366-V100	PY CB Eth Sw tch/IBP 1Gb 18/6	SB6	X	X	X	X	X	X	X	X	X	X	X							
S26361-K1304-V200	PY CB Eth Sw tch/IBP 10Gb 18/8	SBAX2	X	X	X	X	X	X	X	X	X	X	X							
S26361-K1533-V100	PY CB Eth Sw tch 10/40Gb 18/8+2	SBAX3		X	X	X		X	X		X									
S26361-K1429-V100	PY CB DCB Sw tch 10Gb 18/6 (Brocade)	Harrier		X	X			X	X				X							
S26361-K1429-V200	PY CB DCB SW 10Gb 18/6/6 Enterprise (Br)	Harrier		X	X			X	X				X							
S26361-K1440-V100	PY CB FEX B22F 10Gb 16/8 (Cisco)	FEX		X	X			X	X											
S26361-K1440-V110	PY CB FEX B22F FET 10Gb 16/8 (Cisco)	FEX		X	X			X	X											
S26361-K1365-V18	PY CB Eth Pass Thru 10Gb 18/18	Eth Pass Thru	X	X	X	X	X	X	X	X	X	X	X	X	X	X	X	X	X	X
S26361-K1305-V14	PY FC Sw tch 8Gb 18/8 14 Port (Brocade)	BR 5450																		X
S26361-K1305-V126	PY FC SW 8G 18/8 26 Perform (Brocade)	BR 5450																		X
S26361-K1305-V26	PY FC SW 8G 18/8 26 Port (Brocade)	BR 5450																		X
S26361-K1527-V14	PY CB FC Sw tch 16Gb 18/8 14 (Brocade)	BR 6545																		X
S26361-K1527-V26	PY CB FC Sw tch 16Gb 18/8 26 (Brocade)	BR 6545																		X
S26361-K1527-V27	PY CB FC Sw tch 16Gb 18/8 26 E (Brocade)	BR 6545																		X
S26361-K1363-V18	PY CB FC Pass Thru 8G 18/18	FC Pass Thru																		X

red marked Connection Blades have sales status 65 -> no longer available

R1

Connection Blades released for BX900 S2 System Unit :



Connection blades with 16 downlink ports do not support slot 17 and slot 18

Order number	Connection Blade Type	installable in CB Slot	Downlink ports (internal)	Uplink ports (external)
S26361-K1304-V100	PY CB Eth Switch/IBP 1Gb 36/12	1/2 3/4 5/6 7/8	36x 1Gb Eth	8x 1Gb Eth (RJ45) 4x 1Gb Eth (SFP)
S26361-K1304-V101	PY CB Eth Switch/IBP 1Gb 36/8+2	1/2 3/4 5/6 7/8	36x 1Gb Eth	8x 1Gb Eth (RJ45) 2x 10Gb Eth (SFP+)
S26361-K1366-V100	PY CB Eth Switch/IBP 1Gb 18/6	1/2 3/4 5/6 7/8	18x 1Gb Eth	6x 1Gb Eth (RJ45)
S26361-K1304-V200	PY CB Eth Switch/IBP 10Gb 18/8	1/2 3/4 5/6	18x 10Gb Eth	8x 10Gb Eth (SFP+)
S26361-K1533-V100	PY CB Eth Switch 10/40Gb 18/8+2	1/2 3/4 5/6	18x 10Gb Eth	8x 10Gb Eth (SFP+) 2x 40Gb Eth (QSFP+)
S26361-K1440-V100	PY CB FEX B22F 10Gb 16/8 (Cisco)	1/2 3/4	16x 10Gb Eth	8x 10Gb Eth (SFP+)
S26361-K1440-V110	PY CB FEX B22F FET 10Gb 16/8 (Cisco)	1/2 3/4	16x 10Gb Eth	8x 10Gb Eth (SFP+)
S26361-K1305-V14	PY FC Switch 8Gb 18/8 14 Port (Brocade)	3/4 5/6	18x 8Gb FC	8x 8Gb FC (SFP+)
S26361-K1305-V126	PY FC SW 8G 18/8 26 Perform (Brocade)	3/4 5/6	18x 8Gb FC	8x 8Gb FC (SFP+)
S26361-K1305-V26	PY FC SW 8G 18/8 26 Port (Brocade)	3/4 5/6	18x 8Gb FC	8x 8Gb FC (SFP+)
S26361-K1527-V14	PY CB FC Switch 16Gb 18/8 14 (Brocade)	3/4 5/6	18x 16Gb FC	8x 16Gb FC (SFP+)
S26361-K1527-V26	PY CB FC Switch 16Gb 18/8 26 (Brocade)	3/4 5/6	18x 16Gb FC	8x 16Gb FC (SFP+)
S26361-K1527-V27	PY CB FC Switch 16Gb 18/8 26 E (Brocade)	3/4 5/6	18x 16Gb FC	8x 16Gb FC (SFP+)
S26361-K1363-V18	PY CB FC Pass Thru 8G 18/18	3/4 5/6	18x 4 / 8Gb FC	18x 8Gb FC (SFP+)
S26361-K1365-V18	PY CB Eth Pass Thru 10Gb 18/18	1/2 3/4 5/6	18x 10Gb Eth	18x 10Gb Eth (SFP+)
S26361-K1336-V200	PY CB IB Switch 40Gb 18/18	3/4 5/6 7/8	18x 40Gb IB	18x 40Gb IB (QSFP)
S26361-K1423-V200	PY CB IB Switch 56Gb 18/18	3/4 5/6 7/8	18x 56Gb IB	18x 56Gb IB (QSFP)
S26361-K1391-V300	PY CB SAS Switch 6Gb 18/6	5/6	18x 6Gb SAS	6x 6Gb SAS (SFF8088)

red marked Connection Blades have sales status 65 -> no longer available



There is no Connection Blade included in the System Unit.

S

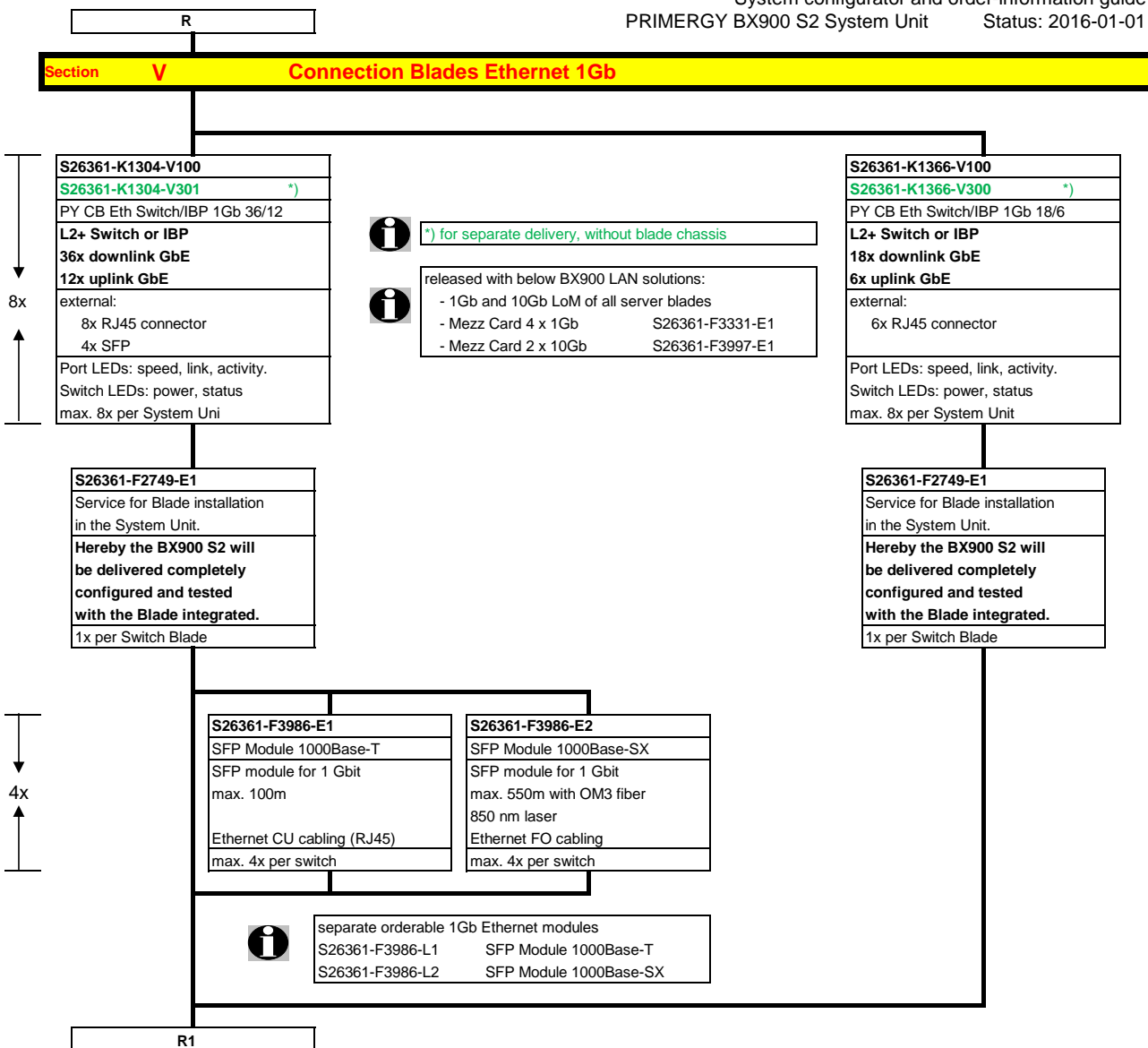

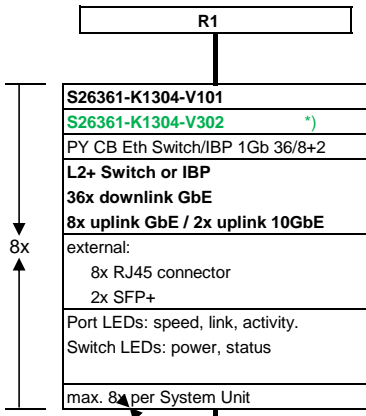

S26361-K1304-V101
S26361-K1304-V302 *)
PY CB Eth Switch/IBP 1Gb 36/8+2
L2+ Switch or IBP
36x downlink GbE
8x uplink GbE / 2x uplink 10GbE
external: 8x RJ45 connector 2x SFP+
Port LEDs: speed, link, activity. Switch LEDs: power, status
max. 8x per System Unit

i *) for separate delivery, without blade chassis

i released with below BX900 LAN solutions:
 - 1Gb and 10Gb LoM of all server blades
 - Mezz Card 4 x 1Gb S26361-F3331-E1
 - Mezz Card 2 x 10Gb S26361-F3997-E1

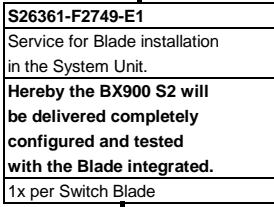

S26361-F2749-E1
Service for Blade installation in the System Unit.
Hereby the BX900 S2 will be delivered completely configured and tested with the Blade integrated.
1x per Switch Blade

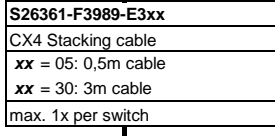

S26361-F3989-E3xx
CX4 Stacking cable
xx = 05: 0,5m cable
xx = 30: 3m cable
max. 1x per switch

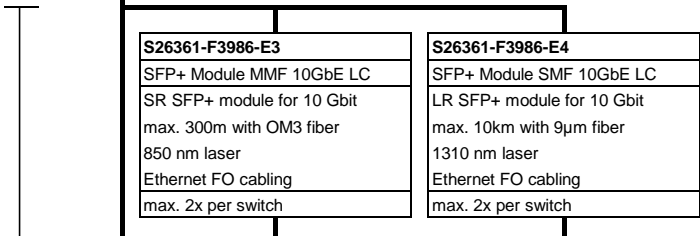

S26361-F3986-E3
SFP+ Module MMF 10GbE LC
SR SFP+ module for 10 Gbit
max. 300m with OM3 fiber
850 nm laser
Ethernet FO cabling
max. 2x per switch

S26361-F3986-E4
SFP+ Module SMF 10GbE LC
LR SFP+ module for 10 Gbit
max. 10km with 9µm fiber
1310 nm laser
Ethernet FO cabling
max. 2x per switch

i separate orderable 10Gb Ethernet modules
 S26361-F3986-L3 SFP+ Module MMF 10GbE LC
 S26361-F3986-L4 SFP+ Module SMF 10GbE LC

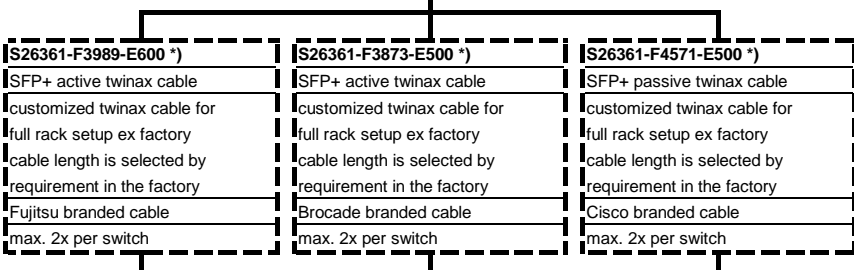

S26361-F3989-E600 *)
SFP+ active twinax cable
customized twinax cable for full rack setup ex factory
cable length is selected by requirement in the factory
Fujitsu branded cable
max. 2x per switch

S26361-F3873-E500 *)
SFP+ active twinax cable
customized twinax cable for full rack setup ex factory
cable length is selected by requirement in the factory
Brocade branded cable
max. 2x per switch

S26361-F4571-E500 *)
SFP+ passive twinax cable
customized twinax cable for full rack setup ex factory
cable length is selected by requirement in the factory
Cisco branded cable
max. 2x per switch

i *) in SA only shown in cabling view

i	separate orderable 10Gb Ethernet cables
S26361-F3989-L102	SFP+ active Twinax Cable Fujitsu 2m
S26361-F3989-L105	SFP+ active Twinax Cable Fujitsu 5m
S26361-F3989-L110	SFP+ active Twinax Cable Fujitsu 10m
S26361-F3873-L501	SFP+ active Twinax Cable Brocade 1m
S26361-F3873-L503	SFP+ active Twinax Cable Brocade 3m
S26361-F3873-L505	SFP+ active Twinax Cable Brocade 5m
S26361-F4571-L101	SFP+ passive Twinax Cable Cisco 1m
S26361-F4571-L103	SFP+ passive Twinax Cable Cisco 3m
S26361-F4571-L105	SFP+ passive Twinax Cable Cisco 5m
S26361-F4571-L107	SFP+ active Twinax Cable Cisco 7m
S26361-F4571-L110	SFP+ active Twinax Cable Cisco 10m

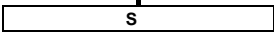

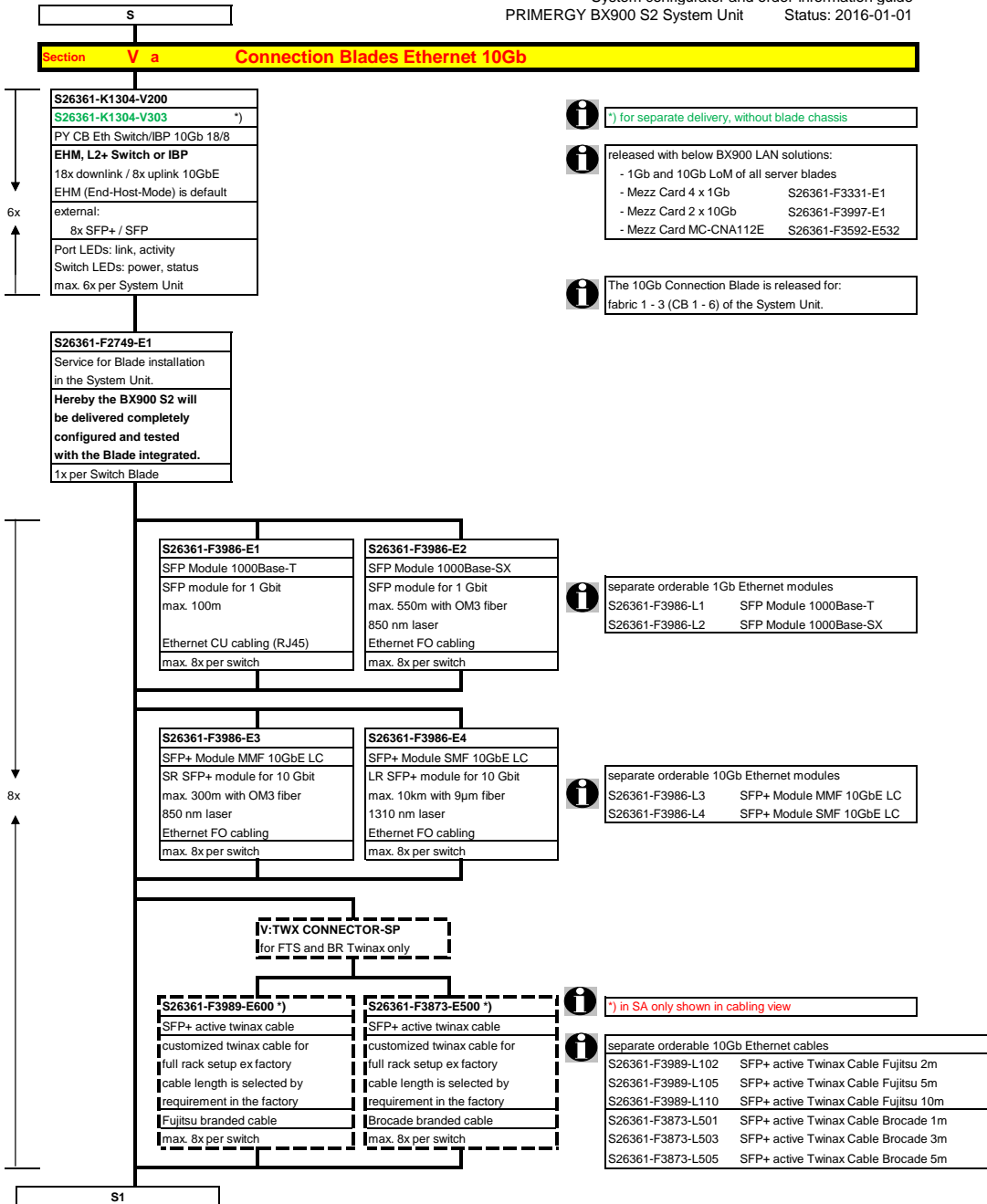

Section V a Connection Blades Ethernet 10Gb

S26361-K1304-V200
S26361-K1304-V303 *)
PY CB Eth Switch/IBP 10Gb 18/8
EHM, L2+ Switch or IBP
18x downlink / 8x uplink 10GbE
EHM (End-Host-Mode) is default
external:
8x SFP+ / SFP
Port LEDs: link, activity
Switch LEDs: power, status
max. 6x per System Unit

i *) for separate delivery, without blade chassis

i released with below BX900 LAN solutions:
 - 1Gb and 10Gb LoM of all server blades
 - Mezz Card 4 x 1Gb S26361-F3331-E1
 - Mezz Card 2 x 10Gb S26361-F3997-E1
 - Mezz Card MC-CNA112E S26361-F3592-E532

i The 10Gb Connection Blade is released for:
 fabric 1 - 3 (CB 1 - 6) of the System Unit.

S26361-F2749-E1
Service for Blade installation in the System Unit.
Hereby the BX900 S2 will be delivered completely configured and tested with the Blade integrated.
1x per Switch Blade

S26361-F3986-E1	S26361-F3986-E2
SFP Module 1000Base-T	SFP Module 1000Base-SX
SFP module for 1 Gbit	SFP module for 1 Gbit
max. 100m	max. 550m with OM3 fiber
Ethernet CU cabling (RJ45)	850 nm laser
max. 8x per switch	Ethernet FO cabling
	max. 8x per switch

i separate orderable 1Gb Ethernet modules
 S26361-F3986-L1 SFP Module 1000Base-T
 S26361-F3986-L2 SFP Module 1000Base-SX

S26361-F3986-E3	S26361-F3986-E4
SFP+ Module MMF 10GbE LC	SFP+ Module SMF 10GbE LC
SR SFP+ module for 10 Gbit	LR SFP+ module for 10 Gbit
max. 300m with OM3 fiber	max. 10km with 9µm fiber
850 nm laser	1310 nm laser
Ethernet FO cabling	Ethernet FO cabling
max. 8x per switch	max. 8x per switch

i separate orderable 10Gb Ethernet modules
 S26361-F3986-L3 SFP+ Module MMF 10GbE LC
 S26361-F3986-L4 SFP+ Module SMF 10GbE LC

V:TWX CONNECTOR-SP
 for FTS and BR Twinax only

S26361-F3989-E600 *)	S26361-F3873-E500 *)
SFP+ active twinax cable	SFP+ active twinax cable
customized twinax cable for full rack setup ex factory	customized twinax cable for full rack setup ex factory
requirement in the factory	requirement in the factory
Fujitsu branded cable	Brocade branded cable
max. 8x per switch	max. 8x per switch

i *) in SA only shown in cabling view

i separate orderable 10Gb Ethernet cables
 S26361-F3989-L102 SFP+ active Twinax Cable Fujitsu 2m
 S26361-F3989-L105 SFP+ active Twinax Cable Fujitsu 5m
 S26361-F3989-L110 SFP+ active Twinax Cable Fujitsu 10m
 S26361-F3873-L501 SFP+ active Twinax Cable Brocade 1m
 S26361-F3873-L503 SFP+ active Twinax Cable Brocade 3m
 S26361-F3873-L505 SFP+ active Twinax Cable Brocade 5m

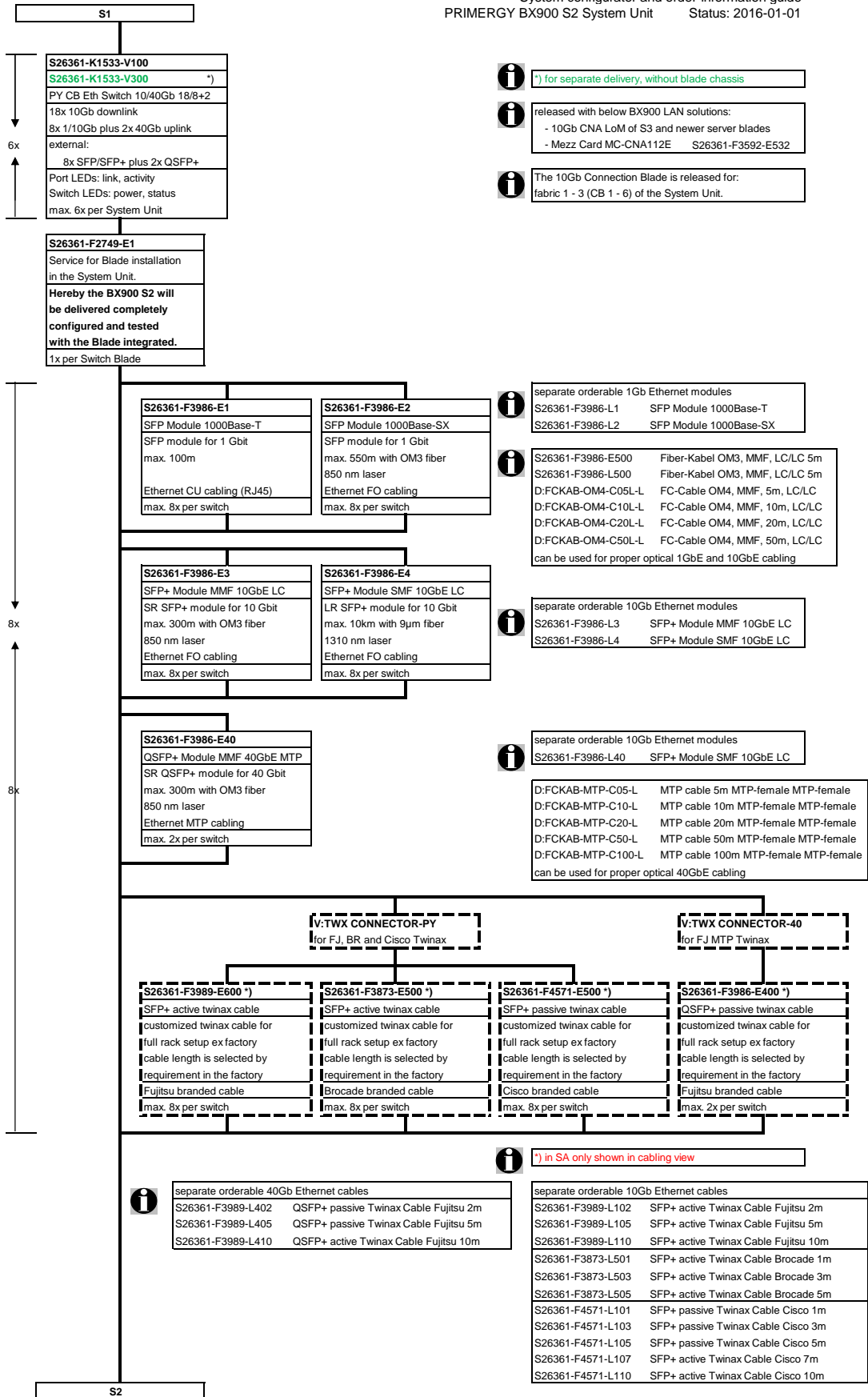

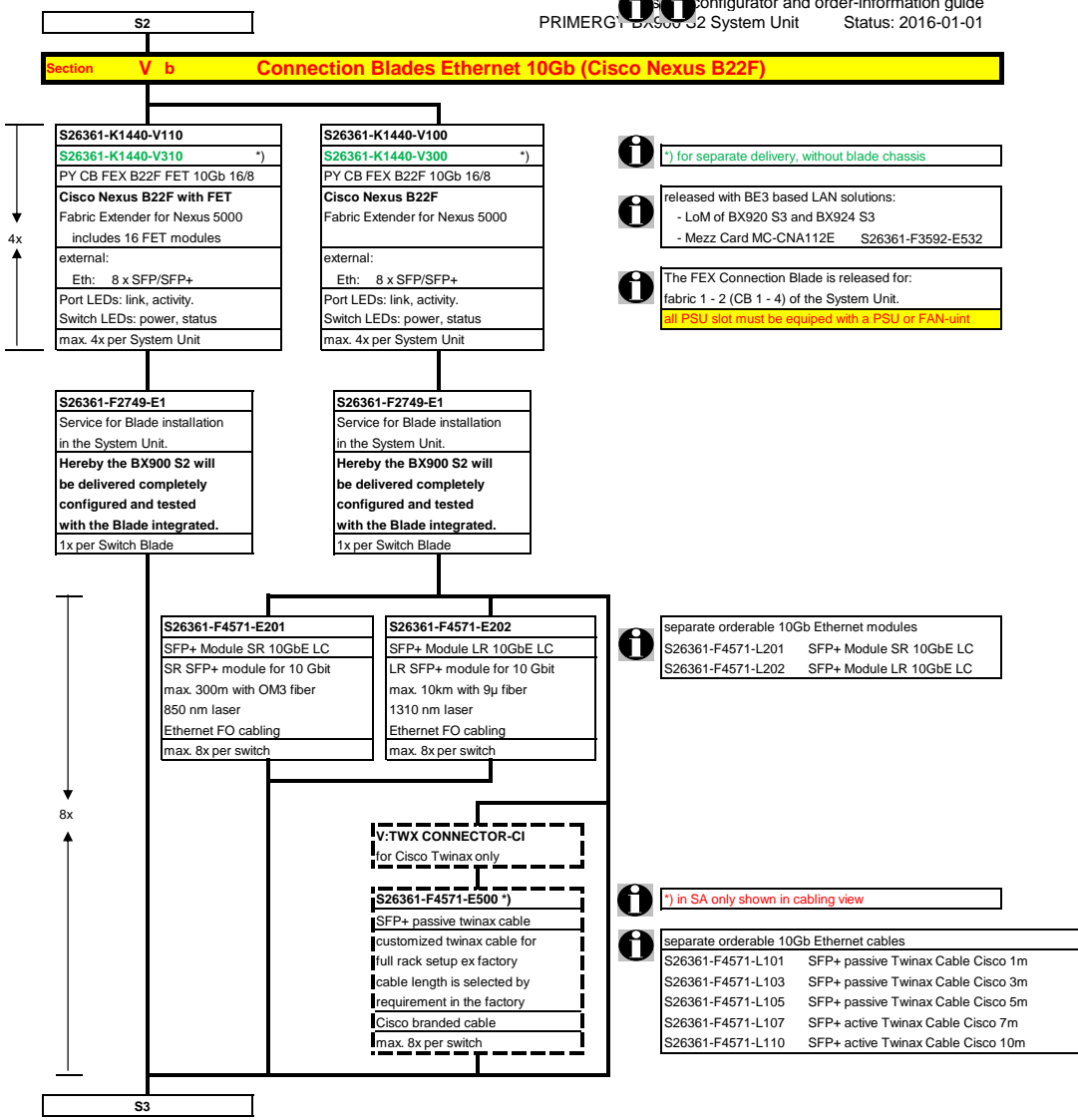

Section V b Connection Blades Ethernet 10Gb (Cisco Nexus B22F)

S26361-K1440-V110
S26361-K1440-V310 *)
 PY CB FEX B22F FET 10Gb 16/8
Cisco Nexus B22F with FET
 Fabric Extender for Nexus 5000
 includes 16 FET modules
 external:
 Eth: 8 x SFP/SFP+
 Port LEDs: link, activity.
 Switch LEDs: power, status
 max. 4x per System Unit

S26361-K1440-V100
S26361-K1440-V300 *)
 PY CB FEX B22F 10Gb 16/8
Cisco Nexus B22F
 Fabric Extender for Nexus 5000
 external:
 Eth: 8 x SFP/SFP+
 Port LEDs: link, activity.
 Switch LEDs: power, status
 max. 4x per System Unit

i *) for separate delivery, without blade chassis

i released with BE3 based LAN solutions:
 - LoM of BX920 S3 and BX924 S3
 - Mezz Card MC-CNA112E S26361-F3592-E532

i The FEX Connection Blade is released for:
 fabric 1 - 2 (CB 1 - 4) of the System Unit.
all PSU slot must be equipped with a PSU or FAN-unit

S26361-F2749-E1
 Service for Blade installation
 in the System Unit.
**Hereby the BX900 S2 will
 be delivered completely
 configured and tested
 with the Blade integrated.**
 1x per Switch Blade

S26361-F2749-E1
 Service for Blade installation
 in the System Unit.
**Hereby the BX900 S2 will
 be delivered completely
 configured and tested
 with the Blade integrated.**
 1x per Switch Blade

S26361-F4571-E201
 SFP+ Module SR 10GbE LC
 SR SFP+ module for 10 Gbit
 max. 300m with OM3 fiber
 850 nm laser
 Ethernet FO cabling
 max. 8x per switch

S26361-F4571-E202
 SFP+ Module LR 10GbE LC
 LR SFP+ module for 10 Gbit
 max. 10km with 9µ fiber
 1310 nm laser
 Ethernet FO cabling
 max. 8x per switch

i separate orderable 10Gb Ethernet modules
 S26361-F4571-L201 SFP+ Module SR 10GbE LC
 S26361-F4571-L202 SFP+ Module LR 10GbE LC

8x

V:TWX CONNECTOR-CI
 for Cisco Twinax only
S26361-F4571-E500 *)
 SFP+ passive twinax cable
 customized twinax cable for
 full rack setup ex factory
 cable length is selected by
 requirement in the factory
 Cisco branded cable
 max. 8x per switch

i *) in SA only shown in cabling view

i separate orderable 10Gb Ethernet cables
 S26361-F4571-L101 SFP+ passive Twinax Cable Cisco 1m
 S26361-F4571-L103 SFP+ passive Twinax Cable Cisco 3m
 S26361-F4571-L105 SFP+ passive Twinax Cable Cisco 5m
 S26361-F4571-L107 SFP+ active Twinax Cable Cisco 7m
 S26361-F4571-L110 SFP+ active Twinax Cable Cisco 10m

S3

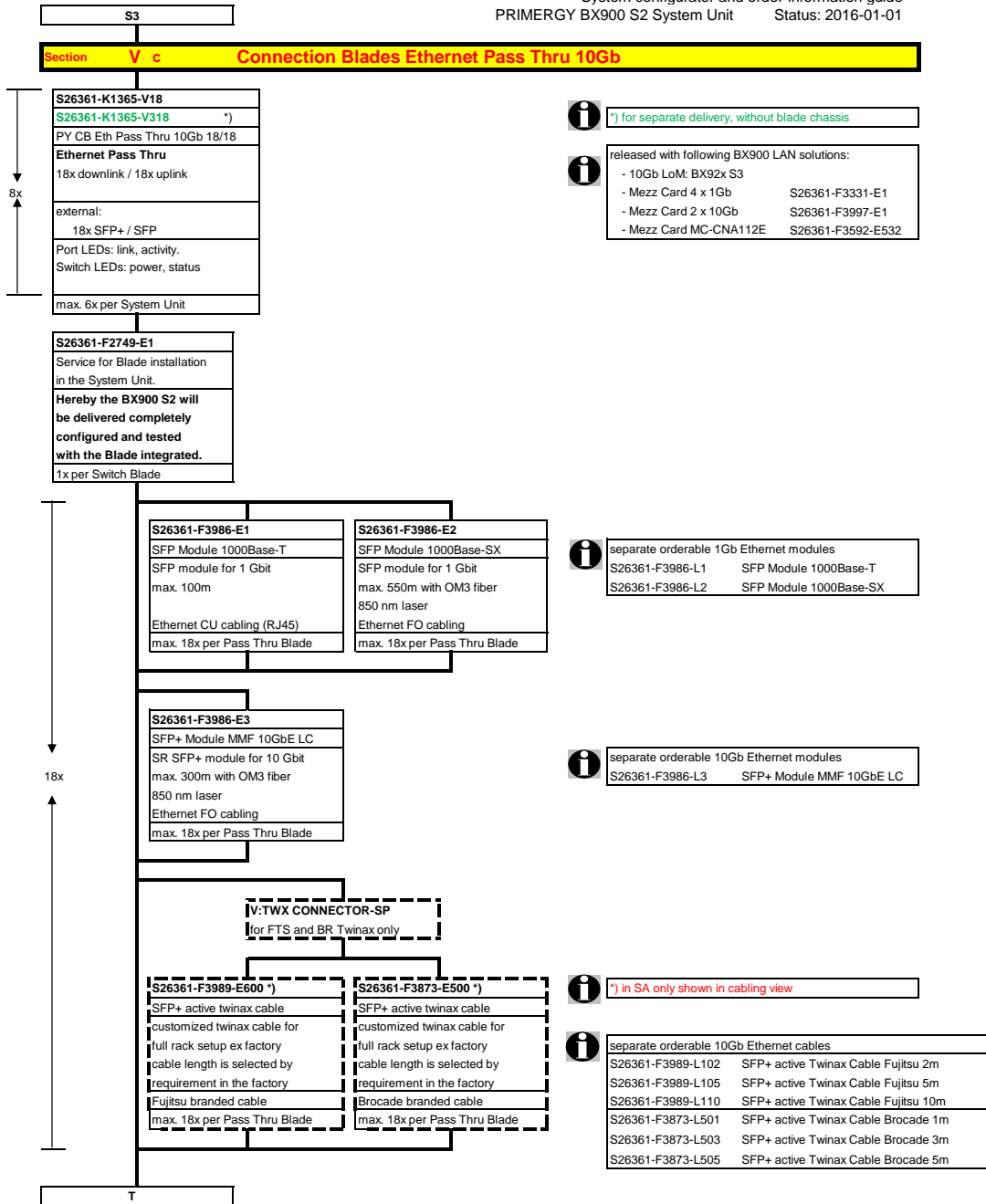

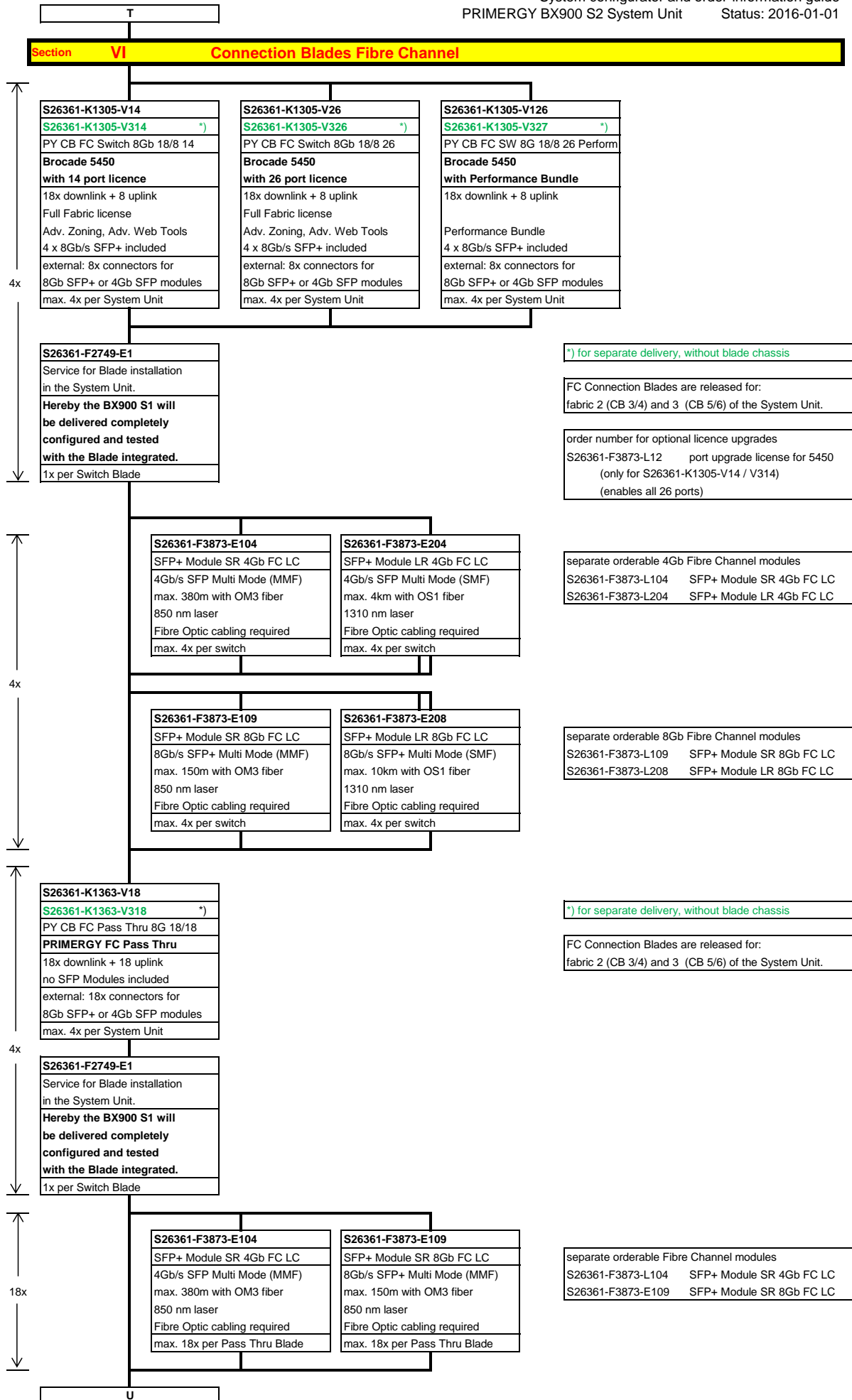

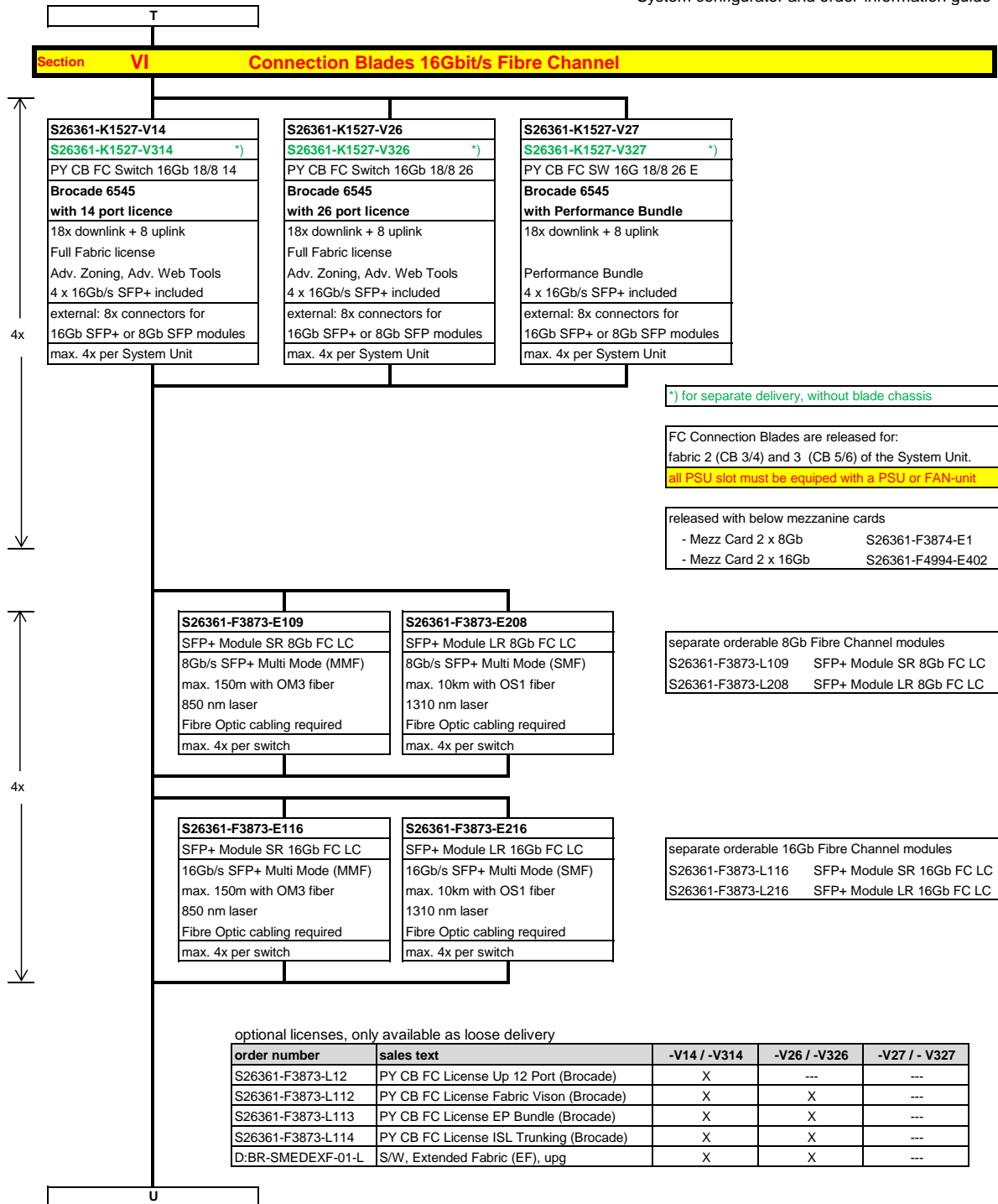

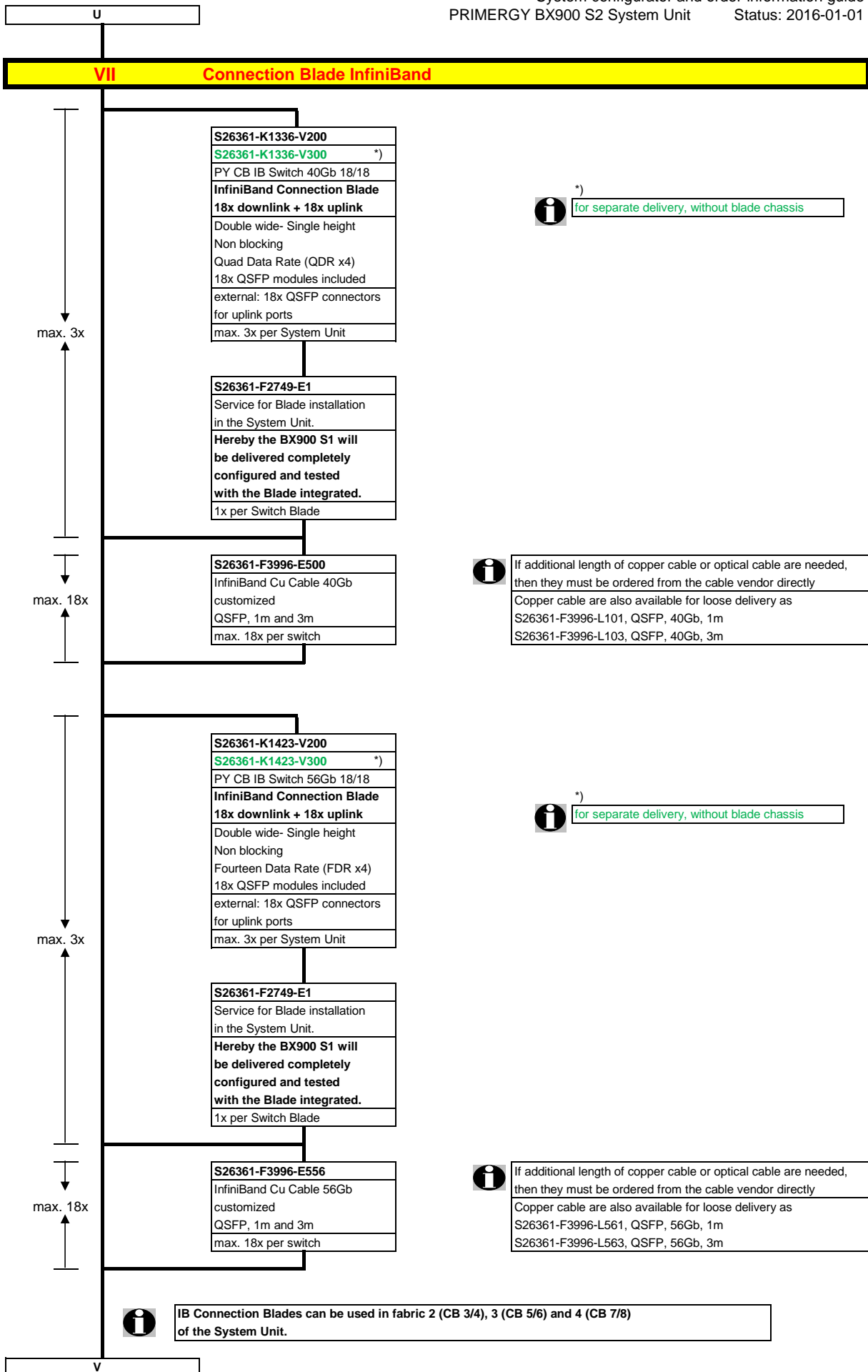

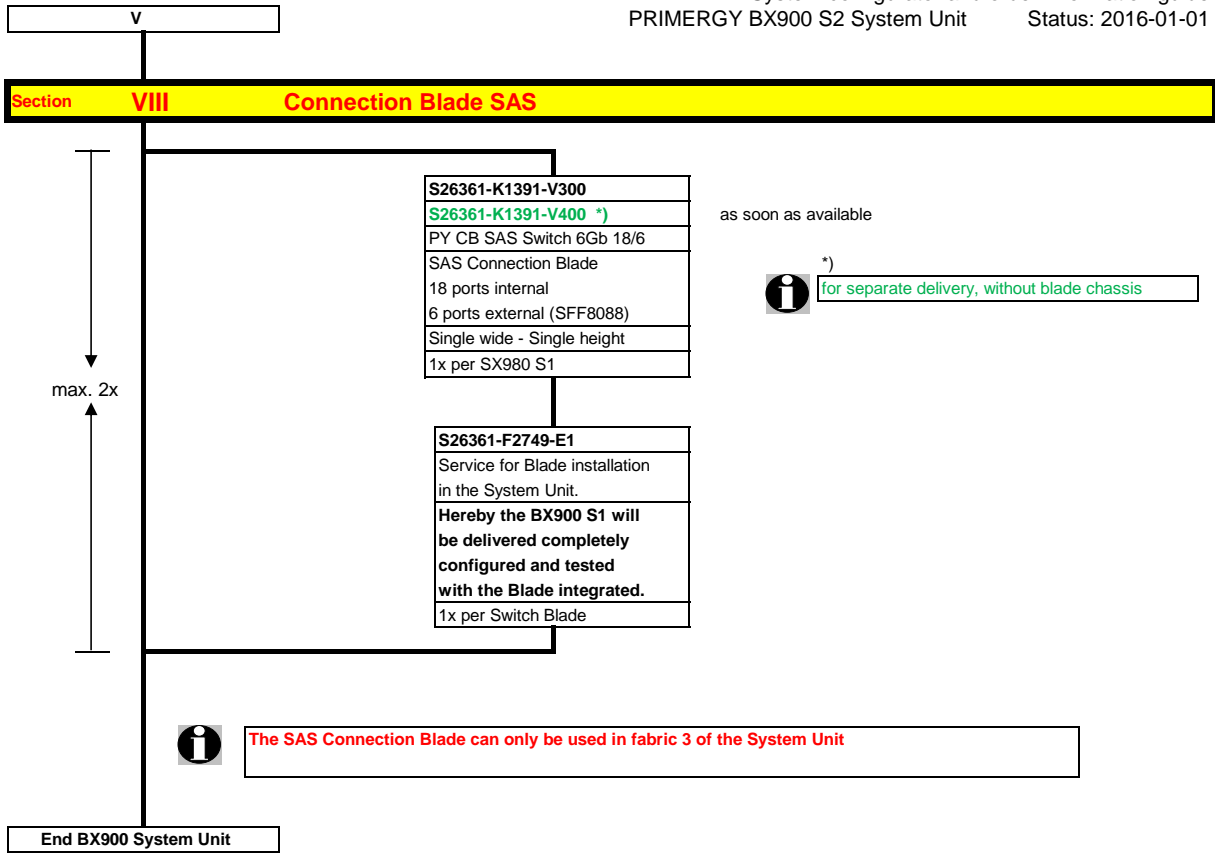

10/40 GbE Twinax Cabling

TWINAX-Cabling with virtual SFP+ modules

Virtual SFP+ modules	Used in	Supported cables	Comment
V:TWX CONNECTOR BR (Brocade)	CB VDX 2730 S26361-K1429-Vxxx Ext. Switch Brocade 8000 EBR800 Ext. Switch VDX 6720-60 S26361-K1452-V100 Ext. Switch VDX 6720 for DI-Blocks D:VDX6720-16-R-M	S26361-F3873-E500 EBR800-TWX-1M-L EBR800-TWX-3M-L EBR800-TWX-5M-L	Brocade customized Brocade 1m Brocade 3m Brocade 5m
V:TWX CONNECTOR CI (Cisco)	CB FEX B22F S26361-K1440-V100	S26361-F4571-E500 S26361-F4571-L110	Cisco customized
V:TWX CONNECTOR PY (Fujitsu)	CB SB11 S26361-K1304-V101 / V301 CB SBAX3 S26361-K1533-V100 / V300 10GB LAN controller D2755 S26361-F3629-E2 / E202 / E702 10Gb CNA OCe10102 S26361-F3592-E2 / E202	S26361-F3989-E600 S26361-F3873-E500 EBR800-TWX-1M-L EBR800-TWX-3M-L EBR800-TWX-5M-L S26361-F4571-E500 S26361-F4571-L110	FJ customized Brocade customized Brocade 1m Brocade 3m Brocade 5m Cisco customized Cisco 10m
V:TWX CONNECTOR SP	CB SBAX2 S26361-K1304-V200 / V300 CB Ethernet Pass Thru S26361-K1365-V18 / V318	S26361-F3989-E600 S26361-F3873-E500 EBR800-TWX-1M-L EBR800-TWX-3M-L EBR800-TWX-5M-L	FJ customized Brocade customized Brocade 1m Brocade 3m Brocade 5m
V:TWX CONNECTOR-40 (40GbE Fujitsu)	CB SBAX3 S26361-K1533-V100 / V300	S26361-F3986-E400 S26361-F3986-L402 S26361-F3986-L405 S26361-F3986-L410	FJ customized Fujitsu 2m Fujitsu 5m Fujitsu 10m

Product number	Connector	Description
V:TWX CONNECTOR-BR	FC TWX 10G connector BR	Twinax Connector Brocade
V:TWX CONNECTOR CI	FC TWX 10G connector CI	Twinax Connector Cisco
V:TWX CONNECTOR PY	FC TWX 10G connector PY	Twinax Connector Primergy
V:TWX CONNECTOR SP	FC TWX 10G connector SBAX	Twinax Connector SBAX2 und PassThru
V:TWX CONNECTOR-40	FC TWX 40G connector PY	Twinax Connector 40GbE SBAX3

Rack-specified Twinax-cable for graphical Cabling within the PRIMECENTER M1 Rack:

S26361-F3873-E500	SFP+ activ Twinax Cable Brocade custom	2x FC TWX 10G connector BR
S26361-F3989-E600	SFP+ aktives Twinax Kabel kundenspez.	2x FC TWX 10G connector PY
S26361-F4571-E500	SFP+ passive Twinax Kabel Cisco custom	2x FC TWX 10G connector CI
S26361-F3986-E400	QSFP+ aktives Twinax Kabel kundenspez.	2x FC TWX 40G connector PY

Twinax-cable for graphical Cabling outside the PRIMECENTER M1 Rack (between racks):

EBR800-TWX-1M-L	SFP+ active Twinax cable BRCD 1m UPG	2x FC TWX 10G connector BR
EBR800-TWX-3M-L	SFP+ active Twinax cable BRCD 3m UPG	2x FC TWX 10G connector BR
EBR800-TWX-5M-L	SFP+ active Twinax cable BRCD 5m UPG	2x FC TWX 10G connector BR
S26361-F4571-L110	SFP+ active Twinax cable Cisco 10m	2x FC TWX 10G connector CI
S26361-F3986-L402	QSFP+ aktives Twinax Kabel 2m	2x FC TWX 40G connector PY
S26361-F3986-L405	QSFP+ aktives Twinax Kabel 5m	2x FC TWX 40G connector PY
S26361-F3986-L410	QSFP+ aktives Twinax Kabel 10m	2x FC TWX 40G connector PY

In Addition the optional configurable Twinax-cable options (not for graphical cabling in systemarchitect usable!)

(to find under chapter "Hardware – Options" of the Blade system units BX900S2 and BX400S1)

S26361-F3873-L501	Brocade 1m
S26361-F3873-L503	Brocade 3m
S26361-F3873-L505	Brocade 5m
S26361-F4571-L101	Cisco 1m
S26361-F4571-L103	Cisco 3m
S26361-F4571-L105	Cisco 5m
S26361-F4571-L107	Cisco 7m
S26361-F3989-L102	FTS 2m
S26361-F3989-L105	FTS 5m
S26361-F3989-L110	FTS 10m

